

2024/5

# DRP™

## Performance Products Low Drag Components



- Hub Defenders™
- Low Drag Bearing Kits
- Low Drag Hub Seals
- Low Drag Bearing Grease
- Installation Tools
- Bearing Packers
- Pinion Defenders™
- Low Drag Rod Ends
- Low Drag Chains
- CIRCLE TRACK
- DRAG RACE
- ROAD RACE
- STREET PERFORMANCE
- TRAILERS

# Hub Defenders™

Unlock Your Hub's Performance!

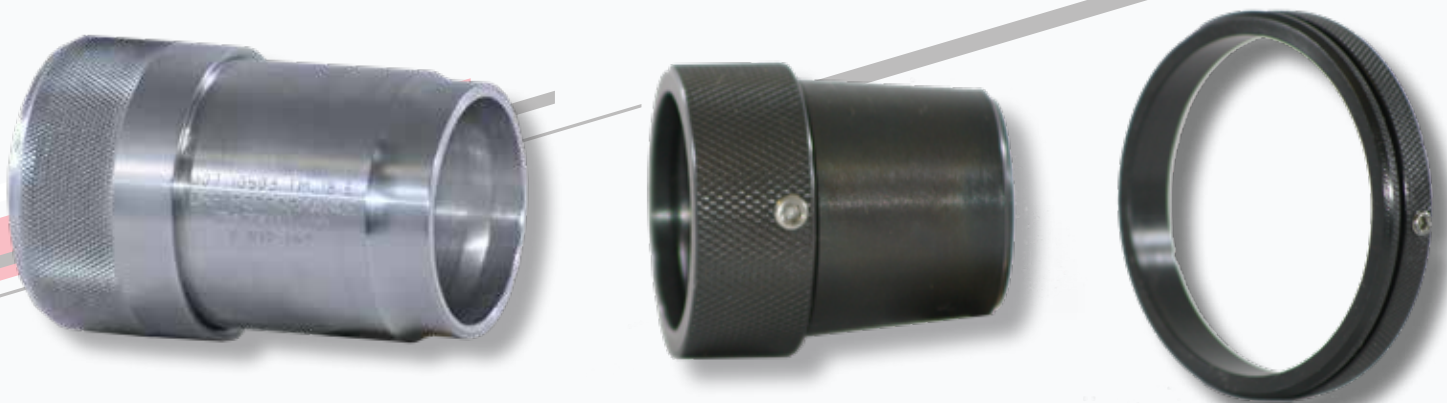

**A Difference You Can Feel!**  
**Available for most popular hub applications.**  
**Race Cars • High Performance Street • Trailers**



Installs Between the Hub Bearings

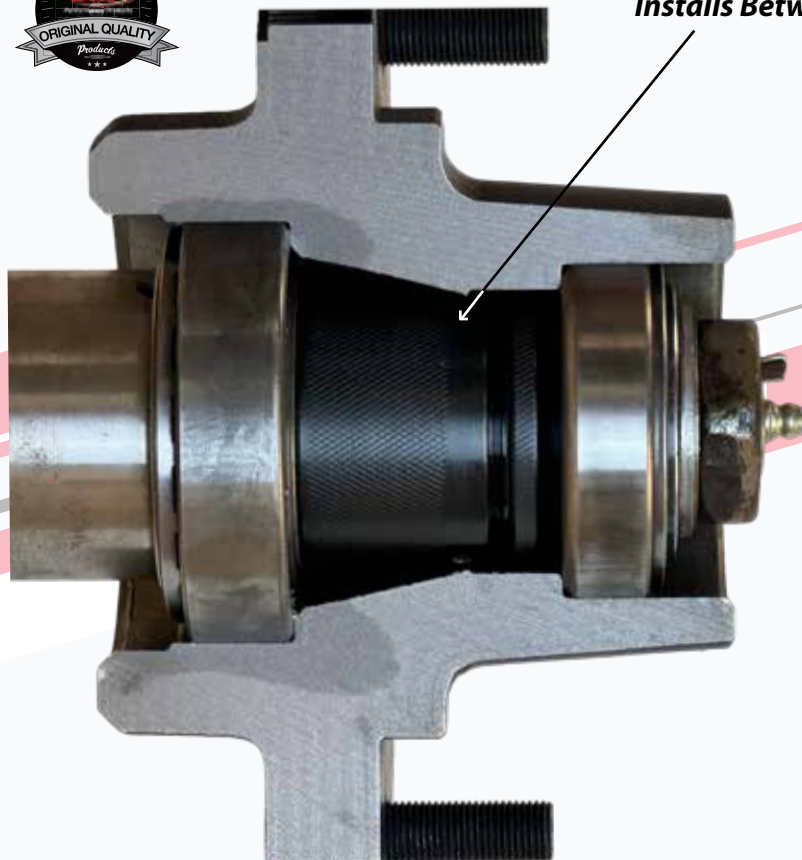

- Adjustable for each hub
- Eliminates excessive bearing pre-load & end-play
- Keeps Bearings Fully Seated & Square to Races
- Eliminates 'Bearing Spin' on Spindle
- Reduces Bearing Temps
- Increases Free Spin by 1200%+!



**Hub Defender™ Installed**  
Torque Spindle Nut to 40 Ft. Lbs.  
[DRPperformance.com](http://DRPperformance.com)

**12 X More Free Spin!**  
**Increases Free Roll Speed in Corner**  
**Reduces Hub Maintenance**

**Custom Applications Available**



888-399-6074  
[DRPperformance.net](http://DRPperformance.net)  
[DRPuniversity.tv](http://DRPuniversity.tv)



# Hub Defender™ Low Drag Bearing Kits

*Reduce Friction. Lower Bearing Temperatures. Increase Performance.*



*We start with the best bearings we can find. Tested on our Hub Dynamometer. Then we process each bearing and race to achieve the finest surface finish. The end result is a premium quality high performance bearing that runs cool and lasts.*

- High Quality Bearings
- Ultra Smooth Surface Finish
- Reduces Friction
- Lowers Temperature
- Reduces Failures
- Increases Bearing Life

*Available for most popular hub applications.  
Race Cars • High Performance Street • Trailers*

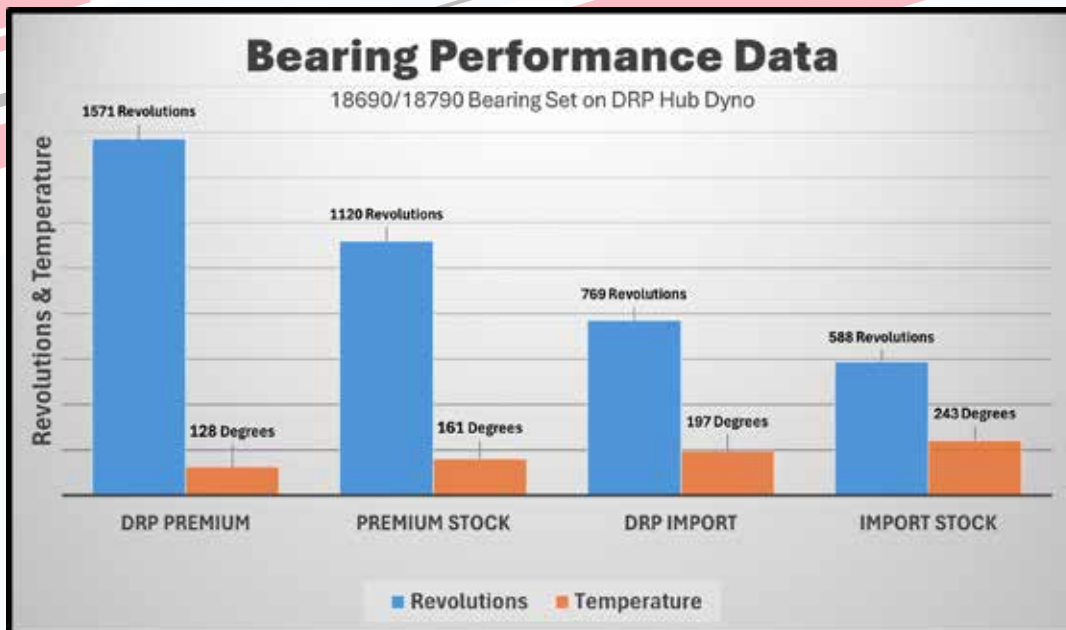

888-399-6074  
DRPperformance.net  
DRPuniversity.tv



# Hub Defender™ Ultra Low Drag Seals

*Reduce Seal Drag. Increase Performance.*



**Ultra Low Drag**



**Air Gap**



**Zero Drag**

- **Increases Hub Free Spin**
- **Light Weight**
- **Reusable**

### **ULD - Ultra Low Drag**

100% Seal, PTFE Sealing Element, Ideal for Most Applications, 10X+ Reduction in Seal Drag vs. Stock Seals, Lightweight Aluminum Housing.

### **AG - Air Gap**

0% Seal - Highest Performance, No Drag, Ideal for Dry, Dedicated Race Applications, Lightweight Billet Aluminum Housing

### **ZD - Zero Drag**

"50%" Seal - Labyrinth Style, Virtually No Drag, Ideal for Dry, Dedicated Race Applications, Billet Aluminum Housing

**Available for many popular hub applications.**

**Race Cars • High Performance Street**

## **Seal Installation & Removal Tools**



007 80500	Seal Driver - W/F & 2" 5x5	\$59.85
007 80507	Seal Driver Winter's & DMI Rear	\$59.85
007 80508	Seal Driver - 2 7/8" Wide Five	\$59.85
007 80509	Seal Driver - 2 7/8" 5x5 Rear	\$59.85
007 80512	Seal Driver - Dirt Modifieds GM Metric, Pinto & GN 5x5 Rear (Reverse-able)	\$59.85
007 80514	Seal Driver - GM Metric Only	\$59.85
007 80515	Seal Remover - W/F & 2" 5x5	\$59.85
007 80530	Seal Driver - Sprint Car Front	\$59.85



**4**



**888-399-6074**  
**DRPperformance.net**  
**DRPuniversity.tv**



# Ultra Low Drag Bearing Grease

*Reduce Friction. Lower Bearing Temperatures. Increase Performance.*



**Guaranteed to be the best high speed wheel bearing grease you've ever used!**

• 50g Syringe Packs 16 Bearings	007 10756	Syringe - 50g	\$45.65
• 100g Cartridge Packs 32 Bearings	007 10753	Mini Cartridge - 100g	\$74.85
• 290g Cartridge Packs 124 Bearings	007 10750	Full Size Cartridge - 390g	\$226.95

**FOR USE ONLY IN HIGH SPEED BEARINGS**



## Tech Tip

### How Much Grease to Use in Your Hub Bearings

More is not always better. Over-packing high speed bearings creates additional heat as the bearings try to evacuate the excess grease. The heat separates the lubricant from the binding agents during evacuation, ultimately leaving the bearing with less lubrication.



A 50% fill, injecting every other bearing roller with grease, is more than sufficient for high performance bearings. No extra grease in the hub is needed, as the bearings have no mechanism to pull the grease from the hub into the bearing.

DRPPerformance.com



DRPUNIVERSITY.TV

Who ever thought wheel bearing grease could be such as drag? Our Ultra Low Drag Wheel Bearing Grease from Kluber Lubrication is unlike any other and by far the best we've tested - by a wide margin!

Teams have won with this grease for years from Daytona to Winchester to Bristol to Martinsville.

We recommend repacking properly set-up hub bearings every 1500-2000 laps or 750-1000 miles for high performance race applications.



888-399-6074  
 DRPperformance.net  
 DRPuniversity.tv



# The Right Tools for the Job.

## Precision Bearing Packers



Mini

You will love this tool!

- Packs Bearing Properly
  - Eliminates Over Packing
  - No Mess!
- 
- Mini Bearing Packer - Uses 100g Cartridges - Universal Design - Packs Any Bearing
  - Full Size - Uses 290g Cartridges - Includes Bearing Specific Seats - Specify Application



Full Size

007 80600 Mini Bearing Packer - Universal  
007 80520 Full Size Precision Bearing

\$89.25  
\$216.95



## Hub Defender™ Installation Tools

Measure and Set Hub Defender™ in 90 seconds!  
Eliminates Trial and Error Hub On & Off

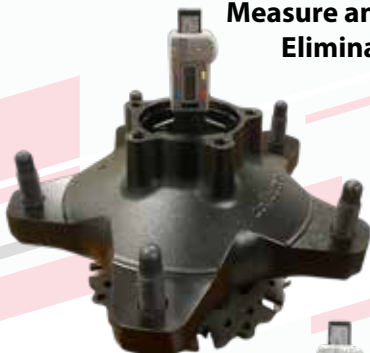

007 20503	Install Tool for Wide Five	\$79.85
007 20505	Install Tool for 2" 5x5	\$79.85
007 20507	Install Tool for Winter's 1 Ton	\$79.85
007 20508	Install Tool for DMI Deuce 'N Half	\$79.85
007 20512	Install Tool for 2 7/8" Wide Five Hubs	\$79.85
007 20513	Install Tool for 2 7/8" 5x5 Rear	\$79.85
007 20518	Install Tool for GN 5x5 Rear	\$79.85
007 20521	Install Tool for GM Metric	\$79.85
007 20530	Install Tool for Sprint Car Front Hubs	\$79.85
007 20531	Install Tool for Pinto Hybrid	\$79.85

## Low Drag Rear End Components



007 105900	Quick Change Pinion Defender	\$48.35
007 105900K	Quick Change Low Drag Bearing Kit	\$510.00
007 205900	Pinion Defender Install Tool - QC	\$79.85

See Page 23 for More Applications



## Low Drag Rod Ends

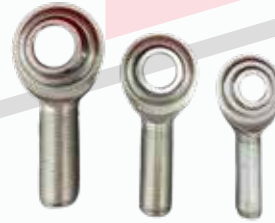

- Reduce Rod End Friction
- Rod Ends are the #1 Source of Suspension Binds

007 52301	3/8" RH Male	\$16.95
007 52302	3/8" LH Male	\$16.95
007 52501	1/2" RH Male	\$21.35
007 52502	1/2" LH Male	\$21.35
007 52503	1/2" RH Female	\$21.35
007 52601	5/8" RH Male	\$26.85
007 52602	5/8" LH Male	\$26.85
007 52701	3/4" RH Male	\$31.60
007 52702	3/4" LH Male	\$31.60
007 52704	3/4" RH Female	\$31.60

## Hub Defenders™ for Trailers & Tow Vehicles



ABS40410	1K-2K# 1" ID Utility Trailer	\$60.00
ABS40415	2K# 1.062" ID Trailer	\$60.00
ABS40417	3500# 1.063" Outer/1.375" Inner	\$60.00
ABS40420	5500#-7000# 1.25" Outer/1.75" Inner	\$60.00

## Hub Dyno

We operate by the motto "You can't improve what you don't measure." To measure friction in wheel hubs we built a Hub Dyno. Our Dyno will spin the hub under full track load while measuring energy consumed, bearing temperature, RPM & more.

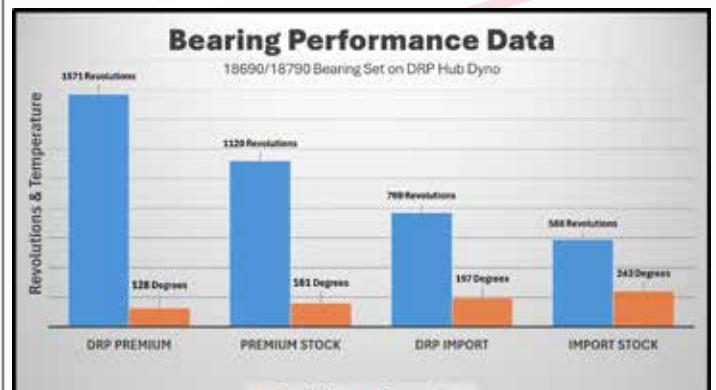

888-399-6074  
DRPperformance.net  
DRPuniversity.tv



# Asphalt Late Models & Tour Modifieds

## Low Drag Hub Parts Kits



- 1 Kit: Bearings, Spacer & Seal
- Choose Style of Seal

### Wide Five Style Hubs

007 10500K	Low Drag Parts Kit - ULD Seal	\$157.35
007 10500KAG	Low Drag Parts Kit - AG Seal	\$164.50
007 10500KZ	Low Drag Parts Kit - ZD Seal	\$165.50
<b>2" 5x5 Style Hubs</b>		
007 10505K	Low Drag Parts Kit - ULD Seal	\$141.65
007 10505KAG	Low Drag Parts Kit - AG Seal	\$148.80
007 10505KZ	Low Drag Parts Kit - ZD Seal	\$149.80

## Low Drag Bearing Kits



- Premium Quality Bearings
- DRP Enhanced Surface Finish
- Up to 100° Lower Temps

### Wide Five Style Hubs

007 10550	Low Drag Bearing Kit - 1 Wheel	\$85.65
007 10553	Low Drag Race Kit - 1 Wheel	\$54.50
<b>2" 5x5 Style Hubs</b>		
007 10555	Low Drag Bearing Kit - 1 Wheel	\$79.95
007 10557	Low Drag Race Kit - 1 Wheel	\$54.85

## Hub Defender™



**Hub Defender™ Installed**

Torque Spindle Nut to 40 Ft. Lbs.

[DRPperformance.com](http://DRPperformance.com)

**12 X More Free Spin!**  
Increases Free Roll Speed in Corner

007 10503	Wide Five Hub Defender™ - Aluminum	\$49.85
007 10506	2" 5x5 Hub Defender™ - Aluminum	\$54.85

## Low Drag Hub Seals



Ultra Low Drag

Air Gap

Zero Drag

007 10559	ULD Seal for Wide Five	\$26.85
007 10559AG	Air Gap Seal for Wide Five	\$34.00
007 10559Z	Zero Drag Seal for Wide Five	\$35.00
007 10564	ULD Seal for 2" 5x5	\$26.85
007 10564AG	Air Gap Seal for 2" 5x5	\$34.00
007 10564Z	Zero Drag Seal for 2" 5x5	\$35.00



888-399-6074  
DRPperformance.net  
DRPuniversity.tv





# Dirt Late Models

## Low Drag Hub Parts Kits



- 1 Kit: Bearings, Spacer & Seal

### Standard Wide Five Style Hubs

007 10500K Low Drag Parts Kit - ULD Seal \$157.35

### Winter's 1 Ton Rear Wide Five Style Hubs

007 10507K Low Drag Parts Kit - ULD Seal \$235.85

### DMI Deuce 'N Half Rear Wide Five Style Hubs

007 10508K Low Drag Parts Kit - ULD Seal \$318.15

## Low Drag Bearing Kits



- Premium Quality Bearings
- DRP Enhanced Surface Finish
- Up to 100° Lower Temps

### Wide Five Style Hubs

007 10550 Low Drag Bearing Kit - 1 Wheel \$85.65

007 10553 Low Drag Race Kit - 1 Wheel \$54.50

### Winter's 1 Ton Rear Wide Five Style Hubs

007 10599 Low Drag Bearing & Race Kit \$143.85

### DMI Deuce 'N Half Rear Wide Five Style Hubs

007 10560 Low Drag Bearing & Race Kit \$218.65

## Hub Defender™



**12 X More Free Spin!**

**Increases Free Roll Speed in Corner**

007 10503 Wide Five Hub Defender™ - Aluminum \$49.85

007 10507 Winter's 1 Ton Hub Defender™ - Aluminum \$63.00

007 10508 DMI Deuce 'N Half Hub Defender™ - Alum. \$63.00

## Low Drag Hub Seals



- ULD - Ultra Low Drag - 100% Seal
- PTFE Sealing Element
- Billet Aluminum Housing
- Reusable

007 10559 ULD Seal for Standard Wide Five \$26.85

007 10558 ULD Seal for Winters 1 Ton WF \$28.58

007 10558 ULD Seal for DMI Deuce 'N Half WF \$28.85

# Dirt Modifieds

## Low Drag Hub Parts Kits



• 1 Kit: Bearings, Spacer & ULD Seal

### Front

007 10521SK	Low Drag Parts Kit - GM Metric/3 Piece Spindles	\$116.95
007 10531K	Low Drag Parts Kit - Pinto Hybrid	\$128.45

### Rear

007 10518K	Low Drag Parts Kit - GN 5x5	\$258.15
007 10513K	Low Drag Parts Kit - 2 7/8" 5x5	\$193.40
007 10505K	Low Drag Parts Kit - 2" 5x5 (368A)	\$141.65
007 10516K	Low Drag Parts Kit - Coleman 5x5	\$167.35



## Hub Defender™



12 X More Free Spin!  
Increases Free Roll Speed in Corner

007 10521S	Hub Defender™ - GM Metric Front	\$49.85
007 10531	Hub Defender™ - Pinto Hybrid Front	\$49.85
007 10523S	Hub Defender™ - Camaro	\$54.85
007 10533	Hub Defender™ - 69-82 Corvette	\$59.85
007 10518	Hub Defender™ - GN 5x5 Rear	\$54.95
007 10505	Hub Defender™ - 2" 5x5 Rear	\$39.85
007 10513	Hub Defender™ - 2 7/8" 5x5 Rear	\$63.00
007 10516	Hub Defender™ - Coleman 5x5 Rear	\$59.85

## Low Drag Hub Seals



- ULD - Ultra Low Drag - 100% Seal
- AG - Air Gap - 0% Seal - Highest Performance
- ZD - Zero Drag - 50% Seal
- Billet Aluminum Housing
- Reusable

007 10577	ULD Seal - GM Metric Front	\$23.85
007 10572	ULD Seal - Pinto Hybrid Front	\$23.85
007 10568	ULD Seal - GN 5x5 Rear	\$26.85
007 10570	ULD Seal - 2 7/8" 5x5 Rear	\$29.85
007 10564	ULD Seal - 2" 5x5 Rear	\$26.85
007 10559	ULD Seal - Coleman 5x5 Rear	\$26.85

## Low Drag Bearing Kits



### Fronts - Premium Bearings

007 10581	Premium Bearing Kit - GM Metric	\$48.25
007 10581R	Premium Race Kit - GM Metric	\$35.30
007 10584H	Premium Bearing Kit - Pinto Hybrid	\$59.45
007 10584HR	Premium Race Kit - Pinto Hybrid	\$41.85

### Rears - Premium Bearings

007 10582	Premium Bearing Kit - GN 5x5 (L610549)	\$178.35
007 10583	Premium Race Kit - GN 5x5 (L610510)	\$88.55
007 10555	Premium Bearing Kit - 2" 5x5 (368A)	\$79.95
007 10557	Premium Race Kit - 2" 5x5 (362A)	\$54.85
007 10550	Premium Bearing Kit-Coleman 5x5 (18690/790)	\$85.65

### Rears - Standard Bearings

007 10582C	Standard Bearing Kit - GN 5x5 (L610549)	\$78.50
007 10583C	Standard Race Kit - GN 5x5 (L610510)	\$42.55
007 10591	Standard Bearing & Race Kit - 2 7/8" 5x5	\$116.20
007 10550C	Standard Bearing Kit-Coleman 5x5 (18690/790)	\$58.50



# North East Dirt Modifieds

## Low Drag Hub Parts Kits



- 1 Kit: Bearings, Races, Spacer & Seal

2 7/8" Wide Five Front Kit (Winter's/Bert/Bicknell)

007 10512K Low Drag Parts Kit - ULD Seal \$185.70

2 7/8" Wide Five Rear Kit (Winter's/Bert/Bicknell)

007 10510K Low Drag Parts Kit - ULD Seal \$185.70

## Low Drag Bearing Kits



- DRP Enhanced Surface Finish
- Up to 100° Lower Temps
- Kit Includes Bearings & Races for 1 Hub

2 7/8" Wide Five Front Bearing Kit (Winter's/Bert/Bicknell)

007 10598 Low Drag Bearing Kit - 1 Wheel \$97.85

2 7/8" Wide Five Rear Bearing Kit (Winter's/Bert/Bicknell)

007 10598 Low Drag Bearing Kit - 1 Wheel \$97.85

## Hub Defender™



**12X More Free Spin!**  
**Increases Free Roll Speed in Corner**  
**Torque Spindle Nut to 40 Ft Lbs!**

007 10512 2 7/8" Wide Five Front Hub Defender™ - Alum. \$63.00

007 10510 2 7/8" Wide Five Rear Hub Defender™ - Alum. \$63.00

\*Hub Defenders™ also available for 6 Pin Style Hubs!

## Low Drag Hub Seals



- ULD - Ultra Low Drag - 100% Seal
- PTFE Sealing Element
- Billet Aluminum Housing
- Reusable

007 10570 ULD Seal for 2 7/8" Wide Five Front \$29.85

007 10570 ULD Seal for 2 7/8" W/F Rear w/ Steel Ring \$29.85

007 10569 ULD Seal for 2 7/8" W/F Rear No Steel Ring \$29.85



**888-399-6074**  
**DRPperformance.net**  
**DRPuniversity.tv**



# Sprint Cars

## Low Drag Hub Parts Kits



- 1 Kit: Bearings, Races, Spacer & Seal

### Sprint Car Front

007 10530K Low Drag Hub Parts Kit - ULD Seal \$144.15

## Low Drag Bearing Kits



- Premium Quality Bearings
- DRP Enhanced Surface Finish
- Up to 100° Lower Temps
- Kit Includes Bearings & Races for 1 Hub

### Sprint Car Front Bearing Kit 2x15120

007 10592 Low Drag Bearing Kit - 1 Wheel \$64.45

### Sprint Car Front Race Kit 2x15250

007 10592R Low Drag Race Kit - 1 Wheel \$59.45

## Hub Defender™



**12X More Free Spin!**  
Increases Free Roll Speed in Corner  
Torque Spindle Nut to 40 Ft Lbs!

007 10530 Sprint Car Front Hub Defender™ - Alum. \$39.85  
\*Hub Defenders™ also available for 6 Pin Style Hubs!

## Low Drag Hub Seals

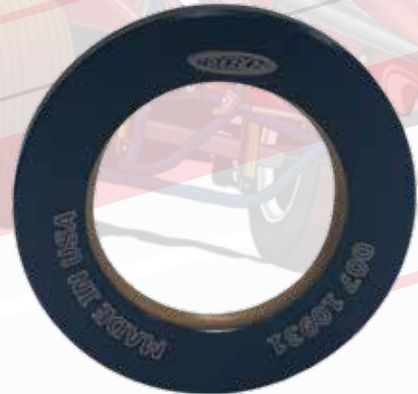

- ULD - Ultra Low Drag - 100% Seal
- PTFE Sealing Element
- Billet Aluminum Housing
- Reusable

007 10931 ULD Seal for Sprint Car Front Hubs \$28.85



888-399-6074  
DRPperformance.net  
DRPuniversity.tv



# Karts, 1/4 Midgets & Bandoleros

## Low Drag Hub Bearings



• 1 Kit = 2 Bearings (1) Inner, (1) Outer

### Kart

007 10620 LD Kart LF Bearing Kit 5/8" \$39.85

007 10621 LD Kart RF Bearing Kit 5/8"-3/4" \$39.85

### Bandolero

007 10626 LD Bandolero Front Hub Bearing Kit \$37.15

## Low Drag Chains



- EK Chain
- Processed like our Bearings
- Incredibly Free
- Measurable Temperature Drop

007 10619 Low Drag Kart/Bandolero Chain \$56.85

Embedded Lube Chain - No Lubrication Needed

007 10619W Low Drag Kart/Bandolero Chain \$64.85



## Hub Defender™



007 105471



007 105472



007 105473



007 105474



007 105478



007 105479

**Increases Free Roll Speed in Corner  
Tighten Spindle Nut Completely!**

007 105471 5/8" Spindle - Narrow Hub \$26.85

007 105472 5/8" Spindle - Wide Hub \$26.85

007 105473 3/4" Inner - 5/8" Outer - Narrow Hub \$26.85

007 105474 3/4" Inner - 5/8" Outer - Wide Hub \$26.85

007 105478 3/4" Spindle \$26.85

007 105479 1" Midget Spindle \$39.85

## Low Drag Axle Bearings



- 206 (Small) & 207 (Large) Kart Axle Bearings
- R20 1/4 Midget / Bandolero Rear Axle Bearings
- All Axle Bearing Include Carbon Air Gap Seals

007 10622 LD Rear Axle Bearing - 206 - Kart Small (ea) \$73.45

007 10624 LD Rear Axle Bearing - 207 - Kart LG(ea) \$85.20

007 10625 LD Rear Axle Bearing Kit (4 Bearings) - 207 -  
1/4 Mid/Bando(ea) \$72.85



888-399-6074  
DRPperformance.net  
DRPuniversity.tv



# Legend Cars

## Low Drag Hub Parts Kits



- 1 Kit: Premium Low Drag Bearings, Spacer & Seal

### Legend Car Low Drag Front Hub Parts Kits

007 10529K Low Drag Hub Parts Kit - ULD Seal \$115.75  
 007 10529K-AG Low Drag Hub Parts Kit-AG Seal \$125.90

## Low Drag Bearing Kits



- Premium Quality Bearings
- DRP Enhanced Surface Finish
- Up to 100° Lower Temps
- Kit Includes Bearings & Races for 1 Hub

007 10585 Legend Car Low Drag Bearing Kit \$47.35  
 007 10585R Legend Car Low Drag Race Kit \$37.05

## Hub Defender™



**12X More Free Spin!**  
**Increases Free Roll Speed in Corner**  
**Torque Spindle Nut to 40 Ft Lbs!**

007 10529 Legend Car Front Bearing Spacer \$49.85

## Low Drag Hub Seals



- ULD - Ultra Low Drag - 100% Seal - PTFE Element
- AG - Air Gap - 0% Seal - No Drag
- Billet Aluminum Housing
- Reusable

007 10575 ULD Seal for Legend Car Front Hubs \$23.85  
 007 10575AG Air Gap Seal for Legend Car Front Hubs \$34.00



**888-399-6074**  
**DRPperformance.net**  
**DRPuniversity.tv**



# Legend Cars

## Low Drag Rear Axle Bearings & Seals

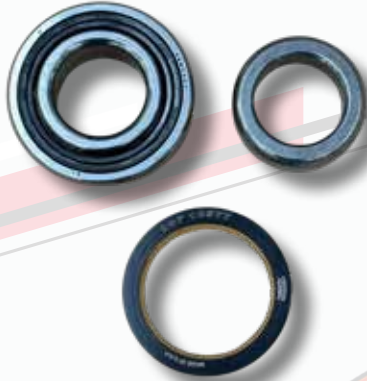

• 1 Kit: Bearings, Races, Spacer & Seal

- 007 10837 Legend Car Low Drag Axle Bearing \$127.65
- 007 10579 Legend Car Low Drag Axle Seal \$23.85
- 007 10837K Legends Car LD Axle Bearing Kit \$153.50

## Legend Hub Defender™ Installation Tool

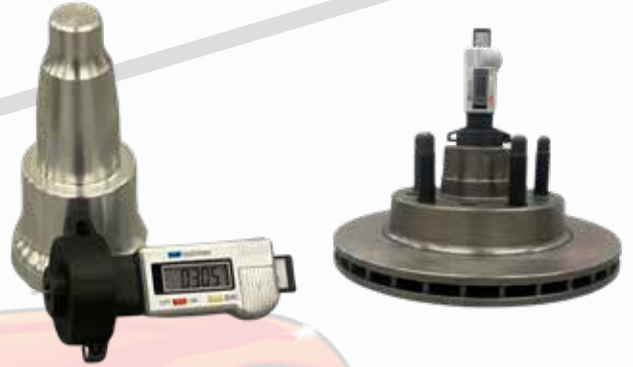

Measure Hub And Set Hub Defender™ Bearing Spacer in under 2 minutes!



- 007 20529 Hub Defender™ Installation Tool \$79.85

## Low Drag Rear End Bearing Kits



- Premium Quality Bearings
- DRP Enhanced Surface Finish
- Reduces Drag & Rear End Temp

Rear End Kit Includes: Low Drag Pinion Bearings & Races, Low Drag Carrier Bearings & Races, Pinion Spacer

\*\*Axle Bearings Sold Separately\*\*

- 007 105904K Complete LD Rear End Bearing Kit \$235.65
- 007 10829 Legend Car Low Drag Pinion Seal \$31.40
- 007 105904 Legend Pinion Defender™ Adjustable Spacer \$48.35

## Legend Bearing Packers & Ultra Low Drag Grease



- Mini Bearing Packer - Uses 100g Cartridges - Universal Design - Packs Any Bearing
- Full Size - Uses 290g Cartridges - Includes Bearing Seats

- 007 80600 Mini Bearing Packer - Universal \$89.25
- 007 80520 Full Size Packer for Wide Five/2" 5x5 \$216.95
- 007 10756 Syringe - 50g \$45.65
- 007 10753 Mini Cartridge - 100g \$74.85
- 007 10750 Full Size Cartridge - 390g \$226.95



888-399-6074  
 DRPperformance.net  
 DRPuniversity.tv



# Stock Cars

## Low Drag Hub Parts Kits



• 1 Kit: Bearings, Spacer & ULD Seal

### Front

007 10520K	Low Drag Parts Kit - GM Full Size	\$133.90
007 10521SK	Low Drag Parts Kit - GM Metric	\$116.95
007 10531K	Low Drag Parts Kit - Pinto Hybrid	\$128.45

### Rear

007 10518K	Low Drag Parts Kit - GN 5x5	\$258.15
007 10513K	Low Drag Parts Kit - 2 7/8" 5x5	\$193.40
007 10505K	Low Drag Parts Kit - 2" 5x5 (368A)	\$141.65



## Hub Defender™



12 X More Free Spin!  
Increases Free Roll Speed in Corner

007 10520	Hub Defender™ - GM Full Size	\$49.85
007 10521S	Hub Defender™ - GM Metric Front	\$49.85
007 10531	Hub Defender™ - Pinto Hybrid Front	\$49.85
007 10523S	Hub Defender™ - Camaro	\$54.85
007 10533	Hub Defender™ - 69-82 Corvette	\$59.85
007 10518	Hub Defender™ - GN 5x5 Rear	\$54.95
007 10505	Hub Defender™ - 2" 5x5 Rear	\$39.85
007 10513	Hub Defender™ - 2 7/8" 5x5 Rear	\$63.00
007 10516	Hub Defender™ - Coleman 5x5 Rear	\$59.85

## Low Drag Hub Seals



• ULD - Ultra Low Drag - 100% Seal  
• Biliet Aluminum Housing  
• Reusable

007 10577	ULD Seal - GM Metric Front	\$23.85
007 10572	ULD Seal - Pinto Hybrid Front	\$23.85
007 10578	ULD Seal - GM Full Size	\$28.85
007 10568	ULD Seal - GN 5x5 Rear	\$29.85
007 10570	ULD Seal - 2 7/8" 5x5 Rear	\$28.85
007 10564	ULD Seal - 2" 5x5 Rear	\$26.85
007 10559	ULD Seal - Coleman 5x5 Rear	\$26.85

## Low Drag Bearing Kits



### Fronts - Premium Low Drag Bearings

007 10580	Premium Bearing Kit - Gm Full Size	\$47.05
007 108580R	Premium Race Kit - GM Full Size	\$40.45
007 10581	Premium Bearing Kit - GM Metric	\$48.25
007 10581R	Premium Race Kit - GM Metric	\$35.30
007 10584H	Premium Bearing Kit - Pinto Hybrid	\$59.45
007 10584HR	Premium Race Kit - Pinto Hybrid	\$41.85

### Rears - Premium Low Drag Bearings

007 10582	Premium Bearing Kit - GN 5x5 (L610549)	\$178.35
007 10583	Premium Race Kit - GN 5x5 (L610510)	\$88.55
007 10555	Premium Bearing Kit - 2" 5x5 (368A)	\$79.95
007 10557	Premium Race Kit - 2" 5x5 (362A)	\$54.85
007 10550	Premium Bearing Kit-Coleman 5x5 (18690/790)	\$85.65

### Rears - Standard Low Drag Bearings

007 10582C	Standard Bearing Kit - GN 5x5 (L610549)	\$78.50
007 10583C	Standard Race Kit - GN 5x5 (L610510)	\$42.55
007 10591	Standard Bearing & Race Kit - 2 7/8" 5x5	\$116.25
007 10550C	Standard Bearing Kit-Coleman 5x5 (18690/790)	\$58.50





# Drag Race

## Low Drag Bearing Kits



### Premium Low Drag Bearings

007 10380	Premium Bearing Kit-Weld Anglia Spindle Mt	\$89.85
007 10380R	Premium Race Kit-Weld Anglia Spindle Mt	\$54.85
007 10585	Premium Bearing Kit-Camaro/Large Strange	\$47.35
007 10585R	Premium Race Kit - Camaro/Large Strange	\$37.05
007 10580	Premium Bearing Kit - GM Full Size	\$47.05
007 108580R	Premium Race Kit - GM Full Size	\$40.45
007 10581	Premium Bearing Kit - GM Metric	\$48.25
007 10581R	Premium Race Kit - GM Metric	\$35.30
007 10584H	Premium Bearing Kit - Mustang	\$59.45
007 10584HR	Premium Race Kit - Mustang	\$41.85
007 10586BR	Prem. Bearing & Race Kit-Mustang Fox Body	\$82.85



## Hub Defender™



12 X More Free Spin!

Increases Roll Speed - Reduces Bearing Temp

007 10520	Hub Defender™ - GM Full Size	\$49.85
007 10521S	Hub Defender™ - GM Metric	\$49.85
007 10531	Hub Defender™ - Mustang	\$49.85
007 10523S	Hub Defender™-Camaro/LG Strange	\$54.85
007 10534	Hub Defender™-Mustang Fox Body	\$54.85
007 105302	Hub Defender™-Anglia 1.2 x .750	\$54.85
007 105303	Hub Defender™-Anglia .982 x .624	\$54.85
007 105304	Hub Defender™-Anglia 1.062 x .75	\$54.85
007 105305	Hub Defender™- Drag 1.75 x1.25	\$54.85

## Low Drag Hub Seals



- ULD - Ultra Low Drag - 100% Seal
- AG - Air Gap - No Drag - Pro Race Only
- ZD - Zero Drag - 50% Seal

### • Billet Aluminum Housing

007 10577	ULD Seal - GM Metric Front	\$23.85
007 10577AG	Air Gap Seal - GM Metric	\$34.00
007 10572	ULD Deal - Mustang II	\$23.85
007 10578	ULD Seal - GM Full Size	\$28.85
007 10563AG	Air Gap Seal - Mustang Fox Body	\$34.00
007 10543AG	Air Gap Seal - Weld Anglia	\$34.00
007 10543Z	Zero Drag Seal - Weld Anglia	\$35.00
007 10944AG	Air Gap Seal - Strange Anglia	\$34.00

## Hub Defender™ Installation Tools



007 20520	Hub Defender™ Install Tool GM Full Size	\$79.85
007 20521	Hub Defender™ Install Tool GM Metric	\$79.85
007 20531	Hub Defender™ Install Tool Pinto Hybrid	\$79.85
007 20523S	Hub Defender™ Install Tool Camaro	\$79.85
007 20534	Hub Defender™ Install Tool Mustang Fox Body	\$79.85
007 205302	Hub Defender™ Install Tool-Anglia 1.2 x .750	\$79.85
007 205303	Hub Defender™ Install Tool Anglia .982 x .624	\$79.85
007 205304	Hub Defender™ Install Tool Anglia 1.062 x .75	\$79.85



888-399-6074  
 DRPperformance.net  
 DRPuniversity.tv





# High Performance STREET & STRIP

AMC								
Year	Model	Inner Bearing	Outer Bearing	Complete Kit	Hub Defender	Low Drag Bearing & Race Kit	ULD Seal	Install Tool
1968 - 1974	Javelin	LM67048 (set 6)	LM11949 (set 2)		10523s	10585BR		20523S
1968 - 1970	AMX	LM67048 (set 6)	LM11949 (set 2)		10523s	10585BR		20523S
BUICK								
Year	Model	Inner Bearing	Outer Bearing	Complete Kit	Hub Defender	Low Drag Bearing & Race Kit	ULD Seal	Install Tool
1973 - 1981	Regal	LM67048 (set6)	M12649 (set 3)	007 10521SK-BR	10521s	10581BR	10577	20521S
1982 - 1987	Regal	LM67048 (set6)	LM12748 (set 34)	007 10521SK-2-BR	10521s	105812BR	10577	20521S

## How to use the Hub Defender™ Installation Tool:



**Step 1:**  
Remove Hub & Clean Bearings.



**Step 2:**  
Place hub on tool with bearings. Place measurement caliper on top. Holding light force on caliper, press zero.



**Step 3:**  
Remove hub. Place bearings and spacer on tool. Place caliper on top. Adjust spacer until caliper reads zero (or other specified measurement.)



Don't see your application listed? Contact us. If we don't have it, we'll build it!

**888-399-6074**  
**DRPperformance.net**  
**DRPuniversity.tv**



## CHEVEROLET

Year	Model	Inner Bearing	Outer Bearing	Complete Kit	Hub Defender	Low Drag Bearing & Race Kit	ULD Seal	Install Tool
1958 - 1966	Impala Drum Brakes	LM67048 (set 6)	LM11949 (set 2)		10523s	10585BR		20523S
1967	Impala	LM67048 (set 6)	LM11949 (set 2)		10523s	10585BR		20523S
1966 - 1968	Caprice drum brakes	LM67048 (set 6)	LM11949 (set 2)		10523s	10585BR		20523S
1967	Caprice disk brakes	LM67048 (set 6)	LM11949 (set 2)		10523s	10585BR		20523S
1968	Caprice , Impala	LM67048 (set 6)	LM11949 (set 2)	007 10523SK-2-BR	10523s	10585BR	10578	20523
1969 - 1976	Caprice , Impala	LM48548 (Set 5)	M12649 (set3)	007 10520K-BR	10520	10580BR	10578	20520
1977 - 1978	Caprice , Impala	LM67048 (set 6)	LM11949 (set 2)	007 10523SK-BR	10523s	10585BR	10577	20523
1979 - 1996	Caprice	LM67048 (set 6)	M12649 (set 3)	007 10521SK-BR	10521s	10581BR	10577	20521
1979 - 1985	Impala	LM67048 (set 6)	M12649 (set 3)	00710521SK-BR	10521s	10581BR	10577	20521
1967- 1969	Camaro	LM67048 (set 6)	LM11949 (set 2)		10523s	10585BR		20523S
1970 - 1978	Camaro	LM67048 (set 6)	LM11949 (set 2)	007 10523SK-BR	10523s	10585BR	10577	20523S
1979 - 1981	Camaro	LM67048 (set 6)	M12649 (set 3)	007 10521SK-BR	10521s	10581BR	10577	20521
1982 - 1987	Camaro	LM67048 (set6)	LM12748 (set 34)	007 10521SK-2-BR	10521s	105812BR	10577	20521
1988 - 1992	Camaro Z28	LM67048 (set 6)	M12649 (set 3)	007 10521SK-BR	10521s	10581BR	10577	20521
1988 - 1992	Camaro Non 1LE brakes	LM67048 (set6)	LM12748 (set 34)	007 10521SK-2-BR	10521s	105812BR	10577	20521
1964 - 1972	Chevelle	LM67048 (set 6)	LM11949 (set 2)		10523s	10585BR		20523S
1973	Chevelle	LM67048 (set 6)	LM11949 (set 2)	007 10523SK-BR	10523s	10585BR	10577	20523S
1963 - 1968	Corvette	LM67048 (set 6)	LM11949 (set 2)		10523s	10585BR		20523S
1969 - 1982	Corvette	LM48548 (Set 5)	M12649 (set 3)	007 10533K-BR	10533	10580BR	10578	20533
1964 - 1982	El Camino	LM67048 (set 6)	LM11949 (set 2)	007 10523SK-BR	10523s	10585BR	10577	20523S
1983 - 1987	El Camino	LM67048 (set6)	LM12748 (set 34)	007 10521SK-2-BR	10521s	105812BR	10577	20521S
1970 - 1972	Monte Carlo	LM67048 (set 6)	LM11949 (set 2)		10523s	10585BR		20523S
1973 - 1978	Monte Carlo	LM67048 (set 6)	LM11949 (set 2)	007 10523SK-BR	10523s	10585BR	10577	20523S
1979 - 1981	Monte Carlo	LM67048 (set 6)	M12649 (set 3)	007 10521SK-BR	10521s	10581BR	10577	20521S
1982 - 1988	Monte Carlo	LM67048 (set6)	LM12748 (set 34)		10521s	105812BR	10577	20521S
1964 - 1968	Nova Chevy II	LM67048 (set 6)	LM11949 (set 2)		10523s	10585BR		20523S
1969 - 1974	Nova	LM67048 (set 6)	LM11949 (set 2)		10523s	10585BR		20523S
1975 - 1978	Nova	LM67048 (set 6)	LM11949 (set 2)	007 10523SK-BR	10523s	10585BR	10577	20523S
1983 - 1990	S10	LM67048 (set6)	LM12748 (set 34)		10521s	105812BR		20521S
1991 - 2004	S10	LM67048 (set6)	LM12748 (set 34)		10521s	105812BR		20521S



888-399-6074  
 DRPperformance.net  
 DRPuniversity.tv



19



# High Performance STREET & STRIP

## DODGE/PLYMOUTH

Year	Model	Inner Bearing	Outer Bearing	Complete Kit	Hub Defender	Low Drag Bearing & Race Kit	ULD Seal	Install Tool
1964 - 1972	Barracuda 9" Brakes	L44649 (set4)	LM11749 (set1)			BR		
1965 - 1972	Barracuda 10" & 11" Brakes	LM67048 (set 6)	LM11949 (set 2)		10539	10585BR		20539
1973 - 1974	Barracuda	L68149 (set17)	LM11949 (set 2)		10542			20542
1970 - 1972	Challenger 10" and 11" Brakes	LM67048 (set 6)	LM11949 (set 2)		10539	10585BR		20539
1973 - 1974	Challenger	L68149 (set17)	LM11949 (set 2)		10542			20542
1978 - 1983	Challenger	L68149 (set17)	LM11949 (set 2)		10542			20542
1966 - 1972	Charger	LM67048 (set 6)	LM11949 (set 2)		10539	10585BR		20539
1973 - 1978	Charger	L68149 (set17)	LM11949 (set 2)		10542			20542
1960 - 1962 - 1965 - 1972	Dart 10" and 11" Brakes	LM67048 (set 6)	LM11949 (set 2)		10539	10585BR		20539
1973 - 1976	Dart	L68149 (set17)	LM11949 (set 2)		10542			20542
1970 - 1972	Duster 10" & 11" Brakes	LM67048 (set 6)	LM11949 (set 2)		10539	10585BR		20539
1973 - 1976	Duster	L68149 (set17)	LM11949 (set 2)		10542			20542
1967 - 1971	GTX	LM67048 (set 6)	LM11949 (set 2)		10539	10585BR		20539
1968 - 1972	Road Runner	LM67048 (set 6)	LM11949 (set 2)		10539	10585BR		20539
1973	Road Runner	L68149 (set17)	LM12749 (set 16)			BR		
1974	Road Runner	JL69349 (set 11)	LM12749 (set 16)			BR		

Don't see your application listed? Contact us. If we don't have it, we'll build it!



Check out our videos and customer install videos on-line.



888-399-6074  
[DRPperformance.net](http://DRPperformance.net)  
[DRPuniversity.tv](http://DRPuniversity.tv)





# High Performance STREET & STRIP

FORD								
Year	Model	Inner Bearing	Outer Bearing	Complete Kit	Hub Defender	Low Drag Bearing & Race Kit	ULD Seal	Install Tool
1968 - 1986	Capri, Cortina	1988 (set 21)	LM11949 (set 2)		10549			20549
1997 - 2002	Expedition	JL69349 (set 11)	lm12749 (set12)				10578	
1963 - 1969	Fairlane	LM67048 (set 6)	LM11949 (set 2)	007 10523SK-1-BR	10523s	10585BR	10572	20523S
1970	Fairlane	L68149 (set13)	LM12749 (set 12)	007 10531K-BR	10531	10584BR	10572	20531
1928 - 1934	Model A & B	15118	09074		105302			
1964 - 1966	Mustang 6 Cylinder Front Drum Brakes	L44649 (set4)	LM11749 (set1)		10528			20528
1964 - 1968	Mustang v8 Front Disk or Drum Brakes	LM67048 (set 6)	LM11949 (set 2)	007 10523SK-1-BR	10523s	10585BR	10572	20523S
1967 - 1969	Mustang 6 Cylinder Front Disk Brakes	LM67048 (set 6)	LM11949 (set 2)	007 10523SK-1-BR	10523s	10585BR	10572	20523S
1969	Mustang 429 Boss V8	LM48548 (Set 5)	LM12749 (set 12)		10534	10586BR		20534
1970 - 1973	Mustang	L68149 (set13)	LM12749 (set 12)	007 10531K-BHR	10531	10584BHR	10572	20531
1974 - 1978	Mustang II 8" rear	L68149 (set17)	LM12749 (set 12)	007 10531K-BR	10531	10584BR	10572	20531
1975 - 1978	Mustang II 6.75 rear	LM48548 (Set 5)	LM12749 (set 12)	007 10531K-1-BR	10531	10586BR	10572	20531
1979 -1993	Mustang 4 Cyl. and V6 Fox Body	L68149 (set17)	LM12749 (set 12)	007 10531K-BHR	10531	10584BHR	10572	20531
1984 -1993	Mustang Fox Body V8	LM48548 (Set 5)	LM12749 (set 12)		10534	10586BR		20534
1971-1980	Pinto	L68149 (set13)	LM12749 (set 12)	007 10531K-BHR	10531	10584BHR	10572	20531

Don't see your application listed? Contact us. If we don't have it, we'll build it!

*Customer Feedback:*

- "I've been racing for over 30 years and have never had a car roll this free!"
- "...the car would literally try to roll off if the ground wasn't level, it was that free!"
- "These spacers are freaking awesome!"
- "badass."
- "Excellent product from DRP. We have them in our cars and will never again be without them."
- "Incredible difference."



888-399-6074  
[DRPperformance.net](http://DRPperformance.net)  
[DRPuniversity.tv](http://DRPuniversity.tv)



# STREET & STRIP

## MAZADA

Year	Model	Inner Bearing	Outer Bearing	Complete Kit	Hub Defender	Low Drag Bearing & Race Kit	ULD Seal	Install Tool
1979 - 1983	RX - 7	Set 32	LM11749 (set1)					
1986 - 1991	RX - 7	JL69349	32204		10535			20535

## PONTIAC

Year	Model	Inner Bearing	Outer Bearing	Complete Kit	Hub Defender	Low Drag Bearing & Race Kit	ULD Seal	Install Tool
1967 - 1969	Firebird	LM67048 (set 6)	LM11949 (set 2)		10523s	10585BR		20523S
1970 - 1978	Firebird	LM67048 (set 6)	LM11949 (set 2)	007 10523SK-BR	10523s	10585BR	10577	20523S
1979 - 1981	Firebird	LM67048 (set 6)	M12649 (set 3)	007 10521SK-BR	10521s	10581BR	10577	20521S
1982 - 1992	Firebird	LM67048 (set 6)	LM12748 (set 34)	007 10521SK-2-BR	10521s	105812BR	10577	20521S
1988 - 1992	Firebird Performance Package	LM67048 (set 6)	M12649 (set 3)	007 10521SK-BR	10521s	10581BR	10577	20521S
1964 - 1972	GTO	LM67048 (set 6)	LM11949 (set 2)		10523s	10585BR		20523S
1973	GTO	LM67048 (set 6)	LM11949 (set 2)	007 10523SK-BR	10523s	10585BR	10577	20523S
1961 - 1969	Tempest	LM67048 (set 6)	LM11949 (set 2)		10523s	10585BR		20523S

## PORSCHE

Year	Model	Inner Bearing	Outer Bearing	Complete Kit	Hub Defender	Low Drag Bearing & Race Kit	ULD Seal	Install Tool
1965 - 1989	911	LM67048 (set 6)	LM11949 (set 2)		10529	10585BR		20529
1983 - 1986	944	LM67048 (set 6)	LM11949 (set 2)		10527	10585BR		20527

## TOYOTA

Year	Model	Inner Bearing	Outer Bearing	Complete Kit	Hub Defender	Low Drag Bearing & Race Kit	ULD Seal	Install Tool
1971 - 4/1974	Celica	L44649 (set4)	LM11749 (set1)			BR		
4/1974 - 1975	Celica	L45449 (set 8)	LM11749 (set1)			BR		
1976 - 1986	Celica	LM67048 (set 6)	LM11949 (set 2)		10529	10585BR		20529

## VOLKSWAGEN

Year	Model	Inner Bearing	Outer Bearing	Complete Kit	Hub Defender	Low Drag Bearing & Race Kit	ULD Seal	Install Tool
1950 - 8/1965	Beetle	30305	30304		10543			20543
8/1965 - 1968	Beetle	L44649 (set4)	30304					
1969 - 1979	Beetle	L45449 (set 8)	LM11749 (set1)					

Don't see your application listed? Contact us. If we don't have it, we'll build it!



# Low Drag Rear End Components

## Pinion Defenders™

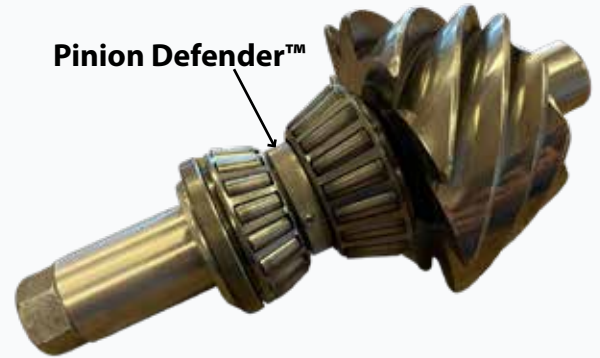

Say goodbye to crush sleeves and shims. Our adjustable Pinion Bearing Spacers allow you to precisely set the pinion pre-load to .0005", reducing drag and improving rear end life. Available for most popular applications. Custom upon request.

Application	Pinion Defender Adjustable Spacer	Low Drag Pinion Bearing Kit	Bearings Included	Low Drag Carrier Bearing Kit	Bearings Included
Ford 9" - Standard Carrier	105901	10824	(2) M88048 (2) M88010	10822	(2) LM603049 (2) LM603011
Ford 9" - Daytona Pinion	105901	10825	HM89443 HM89410 M88048 M88010		
Ford 9" - Strange Carrier	105901			10823	(2) LM104949 (2) LM104911
GM 12 Bolt - Truck	105903				
GM 12 Bolt - Car	105902				
Legends Car	105904	10830	HM88649 HM88610 M86649 M86610	10835	(2) LM501349 (2) 501310
Quick Change - Standard Carrier	105900	10816	88048 88047	10810	(2) 368A (2) 362A
Quick Change - Large Bearing Carrier	105900			10812	(2) 368S (2) 362A

Don't see your application listed? Contact us. If we don't have it, we'll build it!



888-399-6074  
[DRPperformance.net](http://DRPperformance.net)  
[DRPuniversity.tv](http://DRPuniversity.tv)



**Want to find some more speed?  
Check out our Low Drag Components Catalog!**



**Warranty Disclaimer**

Motor sports are very dangerous. Products are sold "as is" and user assumes all risk. DRP Performance Products, Inc. makes no warranty express or implied.

Prices are for reference only and subject to change without notice.

**888-399-6074**  
**DRPperformance.net**  
**DRPuniversity.tv**

*"...let us run with endurance the race that is set before us..." Hebrews 12:1*